

橡膠終端止動緩衝器·圓柱形止位塊

EH 25150.



產品描述

被用作一個彈性止端，軸承腳等。
硬度為55 - 5°A。硬度 (40 - 5°邵氏A和70 - 5°邵氏A) 的要求。

材質

軸承墊片

- 鋼，鍍鋅，鉻化藍
- 不銹鋼 1.4301

螺紋襯套

- 鋼，鍍鋅，鉻化藍
- 不銹鋼 1.4301

本體

- 天然生橡膠，黑色

螺絲

- 鋼，鍍鋅，鉻化藍
- 不銹鋼 1.4301

更多資訊

更多產品

- 支撐腳，衝擊緩衝

圖面

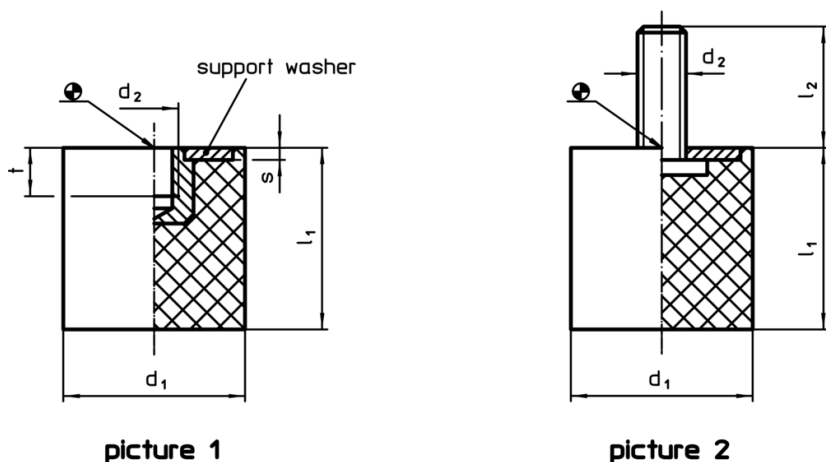





picture 1



picture 2

訂單資訊

尺寸						彈簧 比率 R ~ [N/mm]	荷重能力 max. [N]	彈簧範圍 ~ [mm]	溫度		重量 [g]	RoHS	REACH	品號
d ₁	l ₁	d ₂	l ₂	s	t				min	max.				
[mm]								[°C]						
有母牙 - 相片 1, 鋼														
10	10	M 4	-	1,2	4,0	24	59	2,50	-30	80	1,7	RoHS 認證	contains no SVHC materials	25150.0306
15	15	M 4	-	1,4	4,0	64	241	3,75	-30	80	4,6	RoHS 認證	contains no SVHC materials	25150.0309
15	20	M 4	-	1,4	4,0	57	287	5,00	-30	80	5,7	RoHS 認證	contains no SVHC materials	25150.0310
20	15	M 6	-	2,0	5,0	77	289	3,75	-30	80	10,0	RoHS 認證	contains no SVHC materials	25150.0321
20	20	M 6	-	2,0	5,0	60	302	5,00	-30	80	10,0	RoHS 認證	contains no SVHC materials	25150.0322
20	25	M 6	-	2,0	5,0	48	297	6,25	-30	80	13,0	RoHS 認證	contains no SVHC materials	25150.0323
25	15	M 6	-	2,0	5,0	163	612	3,75	-30	80	14,0	RoHS 認證	contains no SVHC materials	25150.0326
25	20	M 6	-	2,0	5,0	112	560	5,00	-30	80	20,0	RoHS 認證	contains no SVHC materials	25150.0327
25	30	M 6	-	2,0	5,0	68	509	7,50	-30	80	20,0	RoHS 認證	contains no SVHC materials	25150.0328

尺寸						彈簧 比率 R ~ [N/mm]	荷重能力 max. [N]	彈簧範圍 ~ [mm]	 min max. [°C]		 [g]	RoHS	REACH	品號
d ₁	l ₁	d ₂	l ₂	s	t				[mm]					
30	15	M 8	-	2,0	6,5	294	934	3,75	-30	80	20,0	RoHS 認證	contains no SVHC materials	25150.0331
30	20	M 8	-	2,0	6,5	185	924	5,00	-30	80	30,0	RoHS 認證	contains no SVHC materials	25150.0332
30	30	M 8	-	2,0	6,5	117	876	7,50	-30	80	30,0	RoHS 認證	contains no SVHC materials	25150.0333
40	20	M 8	-	2,0	6,5	247	1235	5,00	-30	80	50,0	RoHS 認證	contains no SVHC materials	25150.0341
40	30	M 8	-	2,0	6,5	213	1600	7,50	-30	80	70,0	RoHS 認證	contains no SVHC materials	25150.0342
40	40	M 8	-	2,0	6,5	182	1820	10,00	-30	80	80,0	RoHS 認證	contains no SVHC materials	25150.0343
50	20	M10	-	2,0	7,0	517	2587	5,00	-30	80	80,0	RoHS 認證	contains no SVHC materials	25150.0351
50	30	M10	-	2,0	7,0	327	2453	7,50	-30	80	100,0	RoHS 認證	contains no SVHC materials	25150.0352
50	40	M10	-	2,0	7,0	247	2468	10,00	-30	80	120,0	RoHS 認證	contains no SVHC materials	25150.0353
60	30	M10	-	2,0	7,0	467	3500	7,50	-30	80	140,0	RoHS 認證	contains no SVHC materials	25150.0361
60	50	M10	-	2,0	7,0	269	3367	12,50	-30	80	210,0	RoHS 認證	contains no SVHC materials	25150.0362
70	40	M10	-	3,0	7,0	410	4100	10,00	-30	80	260,0	RoHS 認證	contains no SVHC materials	25150.0371
70	55	M10	-	3,0	7,0	327	4500	13,75	-30	80	340,0	RoHS 認證	contains no SVHC materials	25150.0372
75	30	M12	-	3,0	9,0	600	4500	7,50	-30	80	210,0	RoHS 認證	contains no SVHC materials	25150.0376
75	40	M12	-	3,0	9,0	450	4500	10,00	-30	80	290,0	RoHS 認證	contains no SVHC materials	25150.0377
75	50	M12	-	3,0	9,0	352	4400	12,50	-30	80	350,0	RoHS 認證	contains no SVHC materials	25150.0378
100	40	M16	-	3,0	16,0	810	8100	10,00	-30	80	514,0	RoHS 認證	contains no SVHC materials	25150.0382
100	50	M16	-	3,0	16,0	640	8000	12,50	-30	80	512,0	RoHS 認證	contains no SVHC materials	25150.0384
100	60	M16	-	3,0	16,0	520	7800	15,00	-30	80	698,0	RoHS 認證	contains no SVHC materials	25150.0386
有螺絲 - 相片 2, 鋼														
8	8	M 3	6	1,0	-	20	40	2,00	-30	80	1,0	RoHS 認證	contains no SVHC materials	25150.0403
10	10	M 4	10	1,2	-	24	59	2,50	-30	80	1,9	RoHS 認證	contains no SVHC materials	25150.0406
10	15	M 4	10	1,2	-	21	78	3,75	-30	80	2,4	RoHS 認證	contains no SVHC materials	25150.0407
15	10	M 4	10	1,4	-	77	154	2,00	-30	80	4,0	RoHS 認證	contains no SVHC materials	25150.0408
15	15	M 4	10	1,4	-	64	241	3,75	-30	80	5,0	RoHS 認證	contains no SVHC materials	25150.0409
15	20	M 4	10	1,4	-	57	287	5,00	-30	80	6,2	RoHS 認證	contains no SVHC materials	25150.0410
15	30	M 4	10	1,4	-	48	300	6,25	-30	80	8,0	RoHS 認證	contains no SVHC materials	25150.0411
20	10	M 6	18	2,0	-	126	315	2,50	-30	80	10,0	RoHS 認證	contains no SVHC materials	25150.0421
20	15	M 6	18	2,0	-	77	289	3,75	-30	80	10,0	RoHS 認證	contains no SVHC materials	25150.0422
20	20	M 6	18	2,0	-	60	302	5,00	-30	80	13,0	RoHS 認證	contains no SVHC materials	25150.0423
20	30	M 6	18	2,0	-	38	285	7,50	-30	80	20,0	RoHS 認證	contains no SVHC materials	25150.0424
25	15	M 6	18	2,0	-	163	612	3,75	-30	80	18,0	RoHS 認證	contains no SVHC materials	25150.0426
25	20	M 6	18	2,0	-	112	560	5,00	-30	80	20,0	RoHS 認證	contains no SVHC materials	25150.0427

d ₁	l ₁	尺寸				彈簧 比率 R ~ [N/mm]	荷重能力 max. [N]	彈簧範圍 ~ [mm]				RoHS	REACH	品號	
		d ₂	l ₂	s	t				min	max.					
[mm]														[°C]	[g]
25	30	M 6	18	2,0	-	68	509	7,50	-30	80	25,0	RoHS 認證	contains no SVHC materials	25150.0428	
30	15	M 8	20	2,0	-	294	934	3,75	-30	80	28,0	RoHS 認證	contains no SVHC materials	25150.0431	
30	20	M 8	20	2,0	-	185	924	5,00	-30	80	32,0	RoHS 認證	contains no SVHC materials	25150.0432	
30	25	M 8	20	2,0	-	130	815	6,25	-30	80	38,0	RoHS 認證	contains no SVHC materials	25150.0433	
30	30	M 8	20	2,0	-	117	876	7,50	-30	80	43,0	RoHS 認證	contains no SVHC materials	25150.0434	
40	20	M 8	23	2,0	-	247	1235	5,00	-30	80	55,0	RoHS 認證	contains no SVHC materials	25150.0441	
40	25	M 8	23	2,0	-	247	1546	6,25	-30	80	60,0	RoHS 認證	contains no SVHC materials	25150.0442	
40	30	M 8	23	2,0	-	213	1600	7,50	-30	80	73,0	RoHS 認證	contains no SVHC materials	25150.0443	
40	40	M 8	23	2,0	-	182	1820	10,00	-30	80	83,0	RoHS 認證	contains no SVHC materials	25150.0444	
50	20	M10	28	2,0	-	517	2587	5,00	-30	80	90,0	RoHS 認證	contains no SVHC materials	25150.0451	
50	30	M10	28	2,0	-	327	2453	7,50	-30	80	118,0	RoHS 認證	contains no SVHC materials	25150.0452	
50	40	M10	28	2,0	-	247	2468	10,00	-30	80	140,0	RoHS 認證	contains no SVHC materials	25150.0453	
60	20	M10	28	2,0	-	726	3630	5,00	-30	80	110,0	RoHS 認證	contains no SVHC materials	25150.0461	
60	40	M10	28	2,0	-	340	3400	10,00	-30	80	195,0	RoHS 認證	contains no SVHC materials	25150.0462	
70	40	M10	27	3,0	-	410	4100	10,00	-30	80	265,0	RoHS 認證	contains no SVHC materials	25150.0471	
70	55	M10	27	3,0	-	327	4500	13,75	-30	80	357,0	RoHS 認證	contains no SVHC materials	25150.0472	
75	25	M12	37	3,0	-	752	4700	6,25	-30	80	223,0	RoHS 認證	contains no SVHC materials	25150.0476	
75	40	M12	37	3,0	-	450	4500	10,00	-30	80	310,0	RoHS 認證	contains no SVHC materials	25150.0477	
75	50	M12	37	3,0	-	352	4400	12,50	-30	80	340,0	RoHS 認證	contains no SVHC materials	25150.0478	
100	40	M16	41	3,0	-	810	8100	10,00	-30	80	570,0	RoHS 認證	contains no SVHC materials	25150.0482	
100	50	M16	41	3,0	-	640	8000	12,50	-30	80	656,0	RoHS 認證	contains no SVHC materials	25150.0484	
100	60	M16	41	3,0	-	520	7800	15,00	-30	80	750,0	RoHS 認證	contains no SVHC materials	25150.0486	
有母牙 - 相片 1, 不銹鋼															
10	10	M 4	-	1,2	4,0	24	59	2,50	-30	80	1,4	RoHS 認證	contains no SVHC materials	25150.1306	
15	15	M 4	-	1,4	4,0	64	241	3,75	-30	80	4,5	RoHS 認證	contains no SVHC materials	25150.1309	
15	20	M 4	-	1,4	4,0	57	287	5,00	-30	80	5,8	RoHS 認證	contains no SVHC materials	25150.1310	
20	15	M 6	-	2,0	5,0	77	289	3,75	-30	80	8,1	RoHS 認證	contains no SVHC materials	25150.1321	
20	20	M 6	-	2,0	5,0	60	302	5,00	-30	80	9,8	RoHS 認證	contains no SVHC materials	25150.1322	
20	25	M 6	-	2,0	5,0	48	297	6,25	-30	80	12,0	RoHS 認證	contains no SVHC materials	25150.1323	
25	15	M 6	-	2,0	5,0	163	612	3,75	-30	80	13,0	RoHS 認證	contains no SVHC materials	25150.1326	
25	20	M 6	-	2,0	5,0	112	560	5,00	-30	80	16,0	RoHS 認證	contains no SVHC materials	25150.1327	
25	30	M 6	-	2,0	5,0	68	509	7,50	-30	80	22,0	RoHS 認證	contains no SVHC materials	25150.1328	
30	15	M 8	-	2,0	6,5	294	934	3,75	-30	80	19,0	RoHS 認證	contains no SVHC materials	25150.1331	

d ₁	尺寸					彈簧 比率 R ~ [N/mm]	荷重能力 max. [N]	彈簧範圍 ~ [mm]				RoHS	REACH	品號
	l ₁	d ₂	l ₂	s	t				min	max.				
[mm]							[°C]		[g]					
30	20	M 8	-	2,0	6,5	185	924	5,00	-30	80	23,0	RoHS 認證	contains no SVHC materials	25150.1332
30	30	M 8	-	2,0	6,5	117	876	7,50	-30	80	31,0	RoHS 認證	contains no SVHC materials	25150.1333
40	20	M 8	-	2,0	6,5	247	1235	5,00	-30	80	41,0	RoHS 認證	contains no SVHC materials	25150.1341
40	30	M 8	-	2,0	6,5	213	1600	7,50	-30	80	54,0	RoHS 認證	contains no SVHC materials	25150.1342
40	40	M 8	-	2,0	6,5	182	1820	10,00	-30	80	69,0	RoHS 認證	contains no SVHC materials	25150.1343
50	20	M10	-	2,0	7,0	517	2587	5,00	-30	80	75,0	RoHS 認證	contains no SVHC materials	25150.1351
50	30	M10	-	2,0	7,0	327	2453	7,50	-30	80	98,0	RoHS 認證	contains no SVHC materials	25150.1352
50	40	M10	-	2,0	7,0	247	2468	10,00	-30	80	118,0	RoHS 認證	contains no SVHC materials	25150.1353
60	30	M10	-	2,0	7,0	467	3500	7,50	-30	80	139,0	RoHS 認證	contains no SVHC materials	25150.1361
60	50	M10	-	2,0	7,0	269	3367	12,50	-30	80	206,0	RoHS 認證	contains no SVHC materials	25150.1362
70	40	M10	-	3,0	7,0	410	4100	10,00	-30	80	234,0	RoHS 認證	contains no SVHC materials	25150.1371
70	55	M10	-	3,0	7,0	327	4500	13,75	-30	80	295,0	RoHS 認證	contains no SVHC materials	25150.1372
75	30	M12	-	3,0	9,0	600	4500	7,50	-30	80	201,0	RoHS 認證	contains no SVHC materials	25150.1376
75	40	M12	-	3,0	9,0	450	4500	10,00	-30	80	261,0	RoHS 認證	contains no SVHC materials	25150.1377
75	50	M12	-	3,0	9,0	352	4400	12,50	-30	80	312,0	RoHS 認證	contains no SVHC materials	25150.1378
100	40	M16	-	3,0	16,0	810	8100	10,00	-30	80	513,0	RoHS 認證	contains no SVHC materials	25150.1382
100	50	M16	-	3,0	16,0	640	8000	12,50	-30	80	607,0	RoHS 認證	contains no SVHC materials	25150.1384
100	60	M16	-	3,0	16,0	520	7800	15,00	-30	80	695,0	RoHS 認證	contains no SVHC materials	25150.1386
有螺絲 - 相片 2, 不銹鋼														
8	8	M 3	6	1,0	-	20	40	2,00	-30	80	1,0	RoHS 認證	contains no SVHC materials	25150.1403
10	10	M 4	10	1,2	-	24	59	2,50	-30	80	2,0	RoHS 認證	contains no SVHC materials	25150.1406
10	15	M 4	10	1,2	-	21	78	3,75	-30	80	2,6	RoHS 認證	contains no SVHC materials	25150.1407
15	10	M 4	10	1,4	-	77	154	2,00	-30	80	5,0	RoHS 認證	contains no SVHC materials	25150.1408
15	15	M 4	10	1,4	-	64	241	3,75	-30	80	6,0	RoHS 認證	contains no SVHC materials	25150.1409
15	20	M 4	10	1,4	-	57	287	5,00	-30	80	7,0	RoHS 認證	contains no SVHC materials	25150.1410
15	30	M 4	10	1,4	-	48	300	6,25	-30	80	9,0	RoHS 認證	contains no SVHC materials	25150.1411
20	10	M 6	18	2,0	-	126	315	2,50	-30	80	12,0	RoHS 認證	contains no SVHC materials	25150.1421
20	15	M 6	18	2,0	-	77	289	3,75	-30	80	13,0	RoHS 認證	contains no SVHC materials	25150.1422
20	20	M 6	18	2,0	-	60	302	5,00	-30	80	16,0	RoHS 認證	contains no SVHC materials	25150.1423
20	30	M 6	18	2,0	-	38	285	7,50	-30	80	19,0	RoHS 認證	contains no SVHC materials	25150.1424
25	15	M 6	18	2,0	-	163	612	3,75	-30	80	19,0	RoHS 認證	contains no SVHC materials	25150.1426
25	20	M 6	18	2,0	-	112	560	5,00	-30	80	21,0	RoHS 認證	contains no SVHC materials	25150.1427
25	30	M 6	18	2,0	-	68	509	7,50	-30	80	27,0	RoHS 認證	contains no SVHC materials	25150.1428

尺寸						彈簧 比率 R ~ [N/mm]	荷重能力 max. [N]	彈簧範圍 ~ [mm]	溫度		重量 [g]	RoHS	REACH	品號
d ₁	l ₁	d ₂	l ₂	s	t				min	max.				
[mm]						[°C]								
30	15	M 8	20	2,0	-	294	934	3,75	-30	80	30,0	RoHS 認證	contains no SVHC materials	25150.1431
30	20	M 8	20	2,0	-	185	924	5,00	-30	80	34,0	RoHS 認證	contains no SVHC materials	25150.1432
30	25	M 8	20	2,0	-	130	815	6,25	-30	80	38,0	RoHS 認證	contains no SVHC materials	25150.1433
30	30	M 8	20	2,0	-	117	876	7,50	-30	80	42,0	RoHS 認證	contains no SVHC materials	25150.1434
40	20	M 8	23	2,0	-	247	1235	5,00	-30	80	53,0	RoHS 認證	contains no SVHC materials	25150.1441
40	25	M 8	23	2,0	-	247	1546	6,25	-30	80	60,0	RoHS 認證	contains no SVHC materials	25150.1442
40	30	M 8	23	2,0	-	213	1600	7,50	-30	80	66,0	RoHS 認證	contains no SVHC materials	25150.1443
40	40	M 8	23	2,0	-	182	1820	10,00	-30	80	78,0	RoHS 認證	contains no SVHC materials	25150.1444
50	20	M10	28	2,0	-	517	2587	5,00	-30	80	90,0	RoHS 認證	contains no SVHC materials	25150.1451
50	30	M10	28	2,0	-	327	2453	7,50	-30	80	112,0	RoHS 認證	contains no SVHC materials	25150.1452
50	40	M10	28	2,0	-	247	2468	10,00	-30	80	133,0	RoHS 認證	contains no SVHC materials	25150.1453
60	20	M10	28	2,0	-	726	3630	5,00	-30	80	117,0	RoHS 認證	contains no SVHC materials	25150.1461
60	40	M10	28	2,0	-	340	3400	10,00	-30	80	184,0	RoHS 認證	contains no SVHC materials	25150.1462
70	40	M10	27	3,0	-	410	4100	10,00	-30	80	249,0	RoHS 認證	contains no SVHC materials	25150.1471
70	55	M10	27	3,0	-	327	4500	13,75	-30	80	310,0	RoHS 認證	contains no SVHC materials	25150.1472
75	25	M12	37	3,0	-	752	4700	6,25	-30	80	214,0	RoHS 認證	contains no SVHC materials	25150.1476
75	40	M12	37	3,0	-	450	4500	10,00	-30	80	288,0	RoHS 認證	contains no SVHC materials	25150.1477
75	50	M12	37	3,0	-	352	4400	12,50	-30	80	342,0	RoHS 認證	contains no SVHC materials	25150.1478
100	40	M16	41	3,0	-	810	8100	10,00	-30	80	579,0	RoHS 認證	contains no SVHC materials	25150.1482
100	50	M16	41	3,0	-	640	8000	12,50	-30	80	674,0	RoHS 認證	contains no SVHC materials	25150.1484
100	60	M16	41	3,0	-	520	7800	15,00	-30	80	758,0	RoHS 認證	contains no SVHC materials	25150.1486

應用範例

